



HANDBOOK  
**PIPING ACCESSORIES**

Ed. 2017





# INDEX

CHAPTER 1	<b>Vibration absorbers</b> For refrigeration plants that use HCFC, HFC, HC, HFO or R744 refrigerants	06
CHAPTER 2	<b>Threaded brass fittings</b> For refrigeration plants that use HCFC, HFC, HC, HFO or R744 refrigerants	09
CHAPTER 3	<b>Access fittings and valve cores</b> For refrigeration plants that use HCFC, HFC, HC, HFO or R744 refrigerants	19

---

## THE NATURAL DEVELOPMENT OF QUALITY

Having achieved the goal of fifty-five years working in the Refrigeration and Air Conditioning Industry, Castel's range of quality products is well known and highly appreciated around the world. Quality is the product of our Company philosophy and marks every step of the production cycle. It is certified by the company's Quality Management System (certified by TUV SUD in accordance with the UNI EN ISO 9001:2008 standard), as well as by the various product certifications of compliance with European Directives and European and extra-European Quality Marks.

Product quality is connected with the quality of manufacturing. We produce on high-tech machinery and updated automatic production lines, operating in compliance with the current safety and environmental protection standards.

Castel offers the Refrigeration and Air Conditioning Market and Manufacturers tested certified products suitable for use with the HCF and HFO refrigerants currently used in the Refrigeration & Air Conditioning Industry.

Based on the experience gained in the refrigeration field using fluorinated fluids, Castel is proud to present the Refrigeration and Air Conditioning Market and Manufacturers two complete lines of products developed and proven for use in systems using natural refrigerants: hydrocarbons (HC fluids) and carbon dioxide (R744).





## DIRECTIVE 2014/68/EU ISSUED OF THE EUROPEAN PARLIAMENT AND OF THE COUNCIL OF 15 MAY 2014 ON PRESSURE EQUIPMENT

Directive 2014/68/EU (PED Recast) applies to the design, manufacture and evaluation of compliance of pressure equipment and assemblies with a maximum allowable pressure, PS, greater than 0.5 bar excluding the cases listed in Article 1, Paragraph 2 of the Directive.

Directive 2014/68/EU was transposed into the Italian legal system by Legislative Decree No. 26 dated 15 February 2016, published in the Official Journal of the Republic of Italy No. 53 of 4 March 2016.

The revised PED Recast Directive repeals previous Directive 97/23/EC. More specifically:

- Article 13 of the PED Recast Directive, regarding the classification of pressure equipment, came into force as of 1 June 2015, and repeals Article 9 of the previous PED Directive.
- All other articles of the PED Recast Directive are in force as of 19 July 2016, repealing all articles of the previous PED directive.

All the vibration absorbers and the valve cores illustrated in this technical handbook are considered "Pressure Accessories" according to the definition provided in Article 2, Point 5 of said Directive and are subject to the classification indicated in Article 4, Points 1.c) and 3 of the same Directive.

The threaded brass fittings and the access fittings shown in this chapter are excluded from the scope of said Directive, as specified in Guidelines 1/8 and 1/9, as they are piping components.

## EXTERNAL LEAKAGE

The allowable external leakage complies with the requirements of standards:

- EN 1736: 2009 – Refrigerating systems and heat pumps. Flexible pipe elements, vibration isolators, expansion joints and non-metallic tubes. - Requirements, design and installation.

- EN 14276-2: 2011 – Pressure equipment for refrigerating systems and heat pumps. Part 2: Piping. General requirements.
- EN 378-2: 2016 – Refrigerating systems and heat pumps. Safety and environmental requirements. – Part 2: Design, construction, testing, marking and documentation. Paragraphs 5.2.2.2 and 5.2.2.3
- EN 16084: 2011 – Refrigerating systems and heat pumps - Qualification of tightness of components and joints

## PRESSURE CONTAINMENT

All the products illustrated in this Handbook, if submitted to hydrostatic testing, guarantee a pressure strength at least equal to 1.43 x PS in compliance with Directive 2014/68/EU. All the products illustrated in this Handbook, if submitted to burst test, guarantee a pressure strength at least equal to 3 x PS according to EN 378-2: 2016 Standard.

## WEIGHT

The weights of the items listed in this Handbook include packaging and are not binding.

## WARRANTY

All Castel products are covered by a 12-month warranty. This warranty covers all products or parts thereof that turn out to be defective within the warranty period. In this case, at his own expenses, the customer shall return the defective item with a detailed description of the claimed defects. The warranty does not apply if the defect of the Castel product is due to mistakes by the customer or by third parties, such as incorrect installation, use contrary to Castel instructions, or tampering. In the event of defects found in its products, Castel will only replace the defective goods and will not refund damages of any kind. Castel reserves the right to make changes or modifications to its products at any time without prior notice. The products listed in this handbook are protected according to law.

# CHAPTER 1 ■ VIBRATION ABSORBERS

FOR REFRIGERATION PLANTS THAT USE HCFC, HFC, HC, HFO,  
R744 REFRIGERANTS



## APPLICATIONS

The vibration absorbers shown in this chapter are designed for installation on commercial refrigerating systems and on civil and industrial air conditioning plants. The function of this item is to avoid the transmission of compressor's vibrations to the refrigerating system pipes. They can also compensate small thermal expansion of the piping.

All vibration absorbers can be installed on systems that use the following refrigerant fluids:

- HCFC (R22)
- HFC (R134a, R404A, R407C, R410A, or R507)
- HFO and HFO/HFC mixtures (R1234ze, R448A, R449A, R450A, and R452A)

belonging to Group 2, as defined in Article 13, Chapter 1, Point (b) of Directive 2014/68/EU, with reference to EC Regulation No. 1272/2008.

Furthermore, vibration absorbers up to DN 25, that is model 7690/9, can also be installed on systems using the following refrigeration fluids:

- HFC (R32)
- HFO (R1234yf)
- HC (R290, R600, or R600a)

belonging to Group 1, as defined in Article 13, Chapter 1, Point (a) of Directive 2014/68/EU, with reference to EC Regulation No. 1272/2008.

For specific applications with refrigerant fluids not listed above, please contact Castel Technical Department.

## CONSTRUCTION

The main union between various parts, including the copper/stainless steel connections are TIG welded (figure 1). This solution makes the vibration absorbers particularly resistant to the overheating during connection to the piping.

The main parts of vibration absorbers are manufactured with the following materials:

- Copper pipe EN 12735-1 – Cu-DHP for connections
- Stainless steel EN 10088-1 – 1.4305/1.4301 for fittings
- Stainless steel EN 10028-7 – 1.4541/1.4404 for corrugate flexible

- Stainless steel EN 10028-7 – 1.4301 for net holder
- Stainless steel EN 10088-3 – 1.4301/1.406 for wire “braid”

## INSTALLATION

The vibration absorbers can be installed both on suction and discharge lines, as close as possible to the compressor. They are not designed to compensate possible piping misalignment.

Vibration absorbers should be installed perpendicularly to the direction of vibration. In the case of vertical and horizontal vibrations, two vibrations absorbers should be used perpendicular to each other, as shown in Fig. 2 and 3. For the maximum absorption of vibrations, the refrigerant line should be anchored at the vibration absorber end, as shown in Fig. 2 and 3.

Castel vibration absorbers can be installed vertically too, because they are designed to avoid the retention of condensation in the wavy area near to the connections. There are no issues when employing them at temperatures below 0°C.

Vibration absorbers are not designed to absorb axial or torsional stress. Care should be taken to allow sufficient space to avoid compression or tension, after installation. High-speed refrigerant fluid can produce vibrations and noise phenomena. In this case, it is recommended that a larger size vibration absorber be installed

The connection of the vibration absorbers to the piping is normally performed by brazing. The specific design and construction of vibration absorbers allows the installer to perform this operation without special protection to prevent overheating, generated in this phase.

It is given that best installation calls for the vibration absorber to be linear. A misalignment from the axis of no more than 3% of the length of the corrugated hose is allowed.

**WARNING! Ensure a gap corresponding to the 2% of the total length of the vibration absorber to compensate any extensions due to possible thermal expansion.**

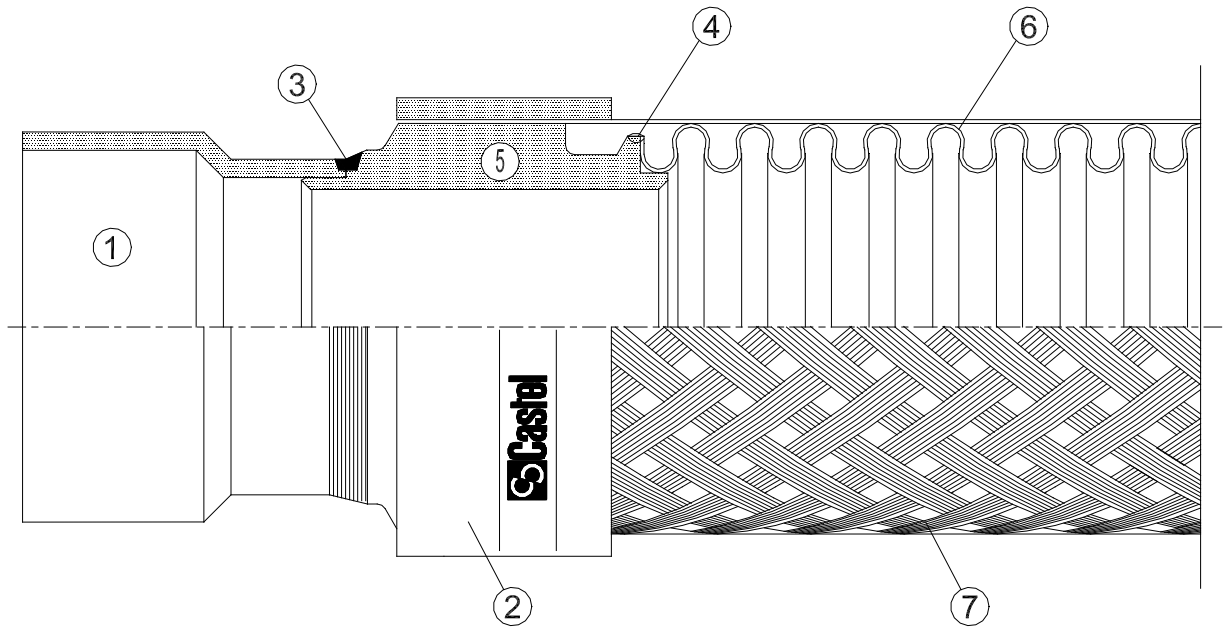

- |                                 |                                |
|---------------------------------|--------------------------------|
| 1 - Copper connection           | 5 - Fitting                    |
| 2 - Net holder                  | 6 - Corrugated flexible        |
| 3 - Copper ends welding         | 7 - Stainless steel wire braid |
| 4 - Corrugated flexible welding |                                |

Fig. 1

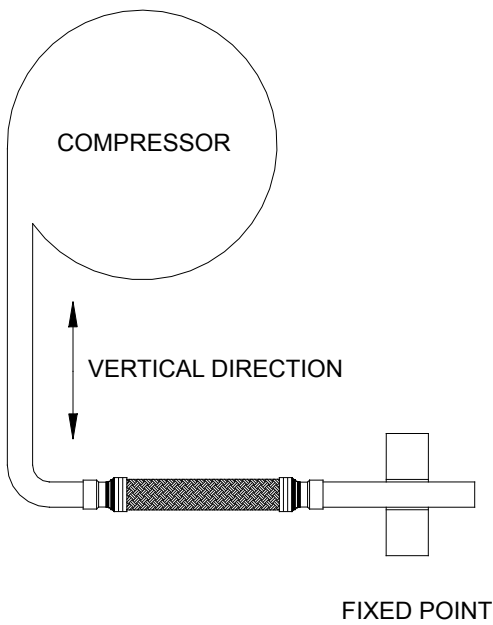

Fig. 2

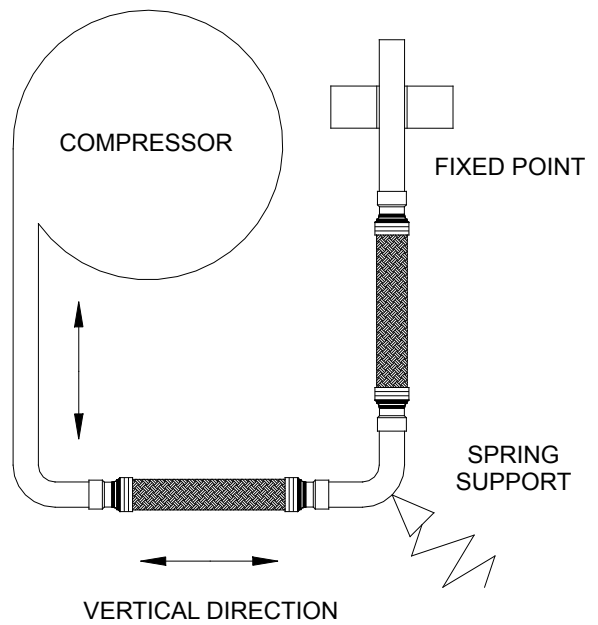
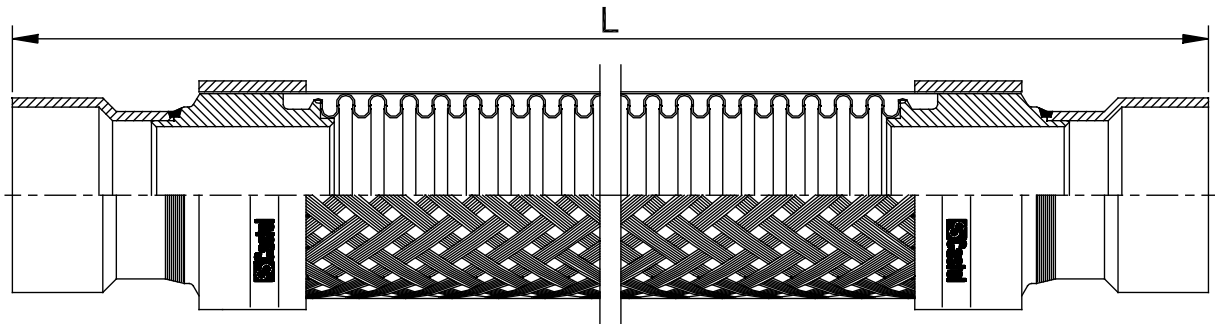

Fig. 3

TABLE 1: General characteristics of vibration absorbers

Catalogue Nr.	Connections		Length [mm]	Weight [g]	Working pressure (PS), depending on fluid temperature [bar]			TA [°C]		Risk Category according to PED Recast
	ODS				-80 / +100 °C	+ 120 °C	+140 °C	min	max	
	[mm]	[inch]								
7690/3	-	3/8	230	91	45	44	43,5	-40	+50	Art. 4.3
7690/M10	10	-		98						
7690/M12	12	-		122						
7690/4	-	1/2		120						
7690/M15	15	-	255	190						
7690/5	16	5/8		200						
7690/M18	18	-		180						
7690/6	-	3/4		180						
7690/7	22	7/8	290	317						
7690/M28	28	-	330	380						
7690/9	-	1.1/8		416						
7690/11	35	1.3/8	375	846						
7690/13	-	1.5/8	430	1088						
7690/M42	42	-		1200						
7690/17	54	2.1/8	510	2060	40	39	38,5			
7690/M64	64	-	690	3312	35	34,5	34			
7690/21	67	2.5/8		3500						
7690/24	76	3		3610						
7690/25	80	3.1/8		3660						
7690/28	89	3.1/2	710	4550	25	24,5	24			
7690/34	108	4.1/4		4770						





# CHAPTER 2

## THREADED BRASS FITTINGS

FOR REFRIGERATION PLANTS THAT USE HCFC, HFC, HC, HFO,  
OR R744 REFRIGERANTS



### APPLICATIONS

The fittings illustrated in this chapter are designed for installation on commercial refrigeration systems and on civil and industrial air conditioning plants that use the following refrigerant fluids:

- HCFC (R22)
- HFC (R134a, R404A, R407C, R410A, or R507)
- HFO and HFO/HFC mixtures (R1234ze, R448A, R449A, R450A, and R452A)
- R744 subcritical and transcritical, limited to components with PS = 120 bar

belonging to Group 2, as defined in Article 13, Chapter 1, Point (b) of Directive 2014/68/EU, with reference to EC Regulation No. 1272/2008.

Furthermore, fittings up to DN 25, they can also be installed on systems that use the following refrigeration fluids:

- HFC (R32)
- HFO (R1234yf)
- HC (R290, R600, or R600a)

belonging to Group 1, as defined in Article 13, Chapter 1, Point (a) of Directive 2014/68/EU, with reference to EC Regulation No. 1272/2008.

For specific applications with refrigerant fluids not listed above, please contact Castel Technical Department.

### OPERATION

The sealing system between the end of a male connection and a union in series 7010, 7020 and 7030 requires a special flaring of the end of copper pipe, the so-called flared connection.

The sealing system between the end of a male connection and a Flare-ODS adapter allows avoiding flaring the end of the copper pipe (national laws of some European countries do not accept this operation) as the end of the copper pipe is brazed into the adapter joint. We wish to remind our customers that perfect seal of the male connector / Flare-ODS adapter can only be ensured using the appropriate tapered gasket, 7580, supplied with the adapter.

The flange joints in series 7630 consist of two brass bushes for brazing to the copper pipes. Once this connection has been made, the joint seal is ensured by the compression of a gasket between the bushes. This compression occurs when the four flange screws are tightened.

### CONSTRUCTION

All nuts from series 7010 to series 7050, and all the elbows, T and cross fittings, from series 7210 to series 7410, are manufactured with hot forged brass EN 12420 – CW 617N. All straight fittings, from series 7110 to series 7170, and all plugs, from series 7510 to series 7520, are machined from brass bars EN 12164 – CW 614N.

Caps in series 7560 and tapered gaskets in series 7580 are from copper Cu – ETP UNI 5649.

The main parts of the flanged joints in series 7630 are made with the following materials:

- Hot forged brass EN 12420 – CW 617N for bushes and flanges.
- Aramid fibres for flange gaskets.

**TABLE 2: General characteristics of flange joints**

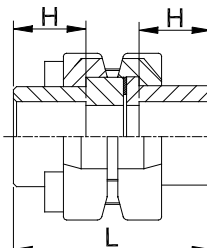
	Catalogue Number	Connections		PS [bar]	TS [°C]		TA [°C]		Dimensions [mm]		Wrench torque min/max [Nm]	Weight [g]	
		ODS			min	max	min	max	H	L			
		Ø [in.]	Ø [mm]										
	7630/7	7/8"	–	45	-40	+130	-40	+50	22	63	20 / 24	612	
	7630/9	1.1/8"	–						23			490	
	7630/11	1.3/8"	35						42 / 50	1100			
	7630/13	1.5/8"	–							24	1412		
	7630/M42	–	42							25	71	68 / 80	2020
	7630/17	2.1/8"	54										

**TABLE 3: General characteristics of unions**

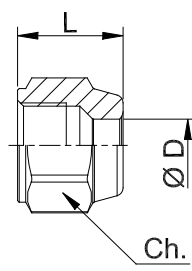
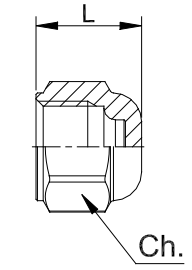
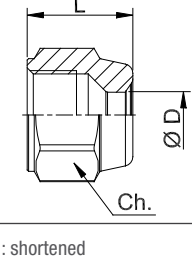
	Catalogue Number	International Reference	SAE Flare	Copper pipe		PS [bar]	Dimensions [mm]			Wrench torque min / max [Nm]	Weight [g]
				Ø [in.]	Ø [mm]		Ø D	L	Ch		
<b>SAE-Flare nuts (inch tubing)</b>											
	7010/22	NS4-4	1/4"	1/4"	6	45	6,5	15,5	17	11 / 14	19
	7010/33	NS4-6	3/8"	3/8"	–		9,7	19,5	22	20 / 25	36
	7010/44	NS4-8	1/2"	1/2"	–		13	22,5	25	34 / 47	50
	7010/55	NS4-10	5/8"	5/8"	16		16,2	25	28	54 / 75	66
	7010/66	NS4-12	3/4"	3/4"	–		19,4	29,5	33	68 / 71	99
	7010/77	NS4-14	7/8"	7/8"	22		22,5	36,5	41	90 / 120	194
	7010/88	NS4-16	1"	1"	–		25,6			120 / 150	150
<b>SAE-Flare cap nuts</b>											
	7020/20	N5-4 CAP NUT	1/4"	blind	blind	120	–	15	16	8,5 / 11,5	16
	7020/X02	N5-5 CAP NUT	5/16"								14
	7020/30	N5-6 CAP NUT	3/8"								14
	7020/40	N5-58 CAP NUT	1/2"								14
<b>SAE-Flare reducing nuts (inch tubing)</b>											
	7020/32	NRS4-64	3/8"	1/4"	6	45	6,5	19,5	22	20 / 25	38
	7020/43	NRS4-86	1/2"	3/8"	–		9,7	22,5	25	34 / 47	52
	7020/54	NRS4-108	5/8"	1/2"	–		13	25	28	54 / 75	71
	7020/65	NRS4-1210	3/4"	5/8"	16		16,2	29,5	33	68 / 71	104
	7020/87	NRS4-1614	1"	7/8"	22		22,5	36,5	41	120 / 150	160

(1) : shortened

Continued

TABLE 3: General characteristics of unions

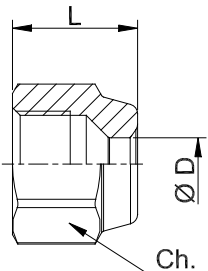
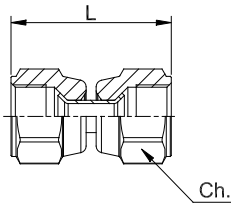
	Catalogue Number	International Reference	SAE Flare	Copper pipe		PS [bar]	Dimensions [mm]			Wrench torque min / max [Nm]	Weight [g]
				Ø [in.]	Ø [mm]		Ø D	L	Ch		
SAE-Flare nuts (metric tubing)											
	7030/2M5	-	1/4"	-	5	45	5,2	15,5	17	11 / 14	19
	7030/3M8		3/8"		8		8,2	19,5	22	20 / 25	35
	7030/3M10		10		10,2		22,5	25	34 / 47	36	
	7030/4M10		10		10,2					52	
	7030/4M12		12		12,2		25	28	54 / 75	51	
	7030/X04 (1)		12		12,5					19,5	46
	7030/4M14		14		14,2		22,5	25	28	54 / 75	48
	7030/5M12		12		12,2		14,2				71
	7030/5M14		14		14,2		29,5	33	68 / 71	69	
	7030/6M14		14		14,2					107	
	7030/6M18		18		18,2		102				
	SAE-Flare twin nuts										
	7050/2	US4-4	1/4"	-	-	45	-	32	17	11 / 14	39
	7050/3	US4-6	3/8"					40	22	20 / 25	75
	7050/4	US4-8	1/2"					46	25	34 / 47	105
	7050/5	US4-10	5/8"					51	28	54 / 75	140

(1) : shortened

TABLE 4: General characteristics of unions

	Catalogue Number	International Reference	Connections		PS [bar]	Dimensions [mm]		Weight [g]
			SAE Flare	NPT		L	Ch	
<b>SAE-Flare unions</b>								
	7110/2	U2-4	1/4"	-	120	38	12	23
	7110/3	U2-6	3/8"			44	17	46
	7110/4	U2-8	1/2"			50	20	73
	7110/5	U2-10	5/8"			58	23	113
	7110/6	U2-12	3/4"			63	27	164
	7110/8	U2-16	1"			72	36	304
<b>Reducing SAE-Flare unions</b>								
	7120/23	UR2-64	1/4" x 3/8"	-	120	42	17	38
	7120/24	UR2-84	1/4" x 1/2"			45	20	58
	7120/34	UR2-86	3/8" x 1/2"			48		66
	7120/35	UR2-106	3/8" x 5/8"			52	23	89
	7120/45	UR2-108	1/2" x 5/8"			54	23	98
	7120/46	UR2-128	1/2" x 3/4"			57,5	27	136
	7120/56	UR2-1210	5/8" x 3/4"			61,5	27	150
<b>SAE Flare / NPT unions</b>								
	7130/2	U1-4B	1/4"	1/4"	120	38,1	14	32
	7130/3	U1-6C	3/8"	3/8"		41,2	17	48
	7130/4	U1-8D	1/2"	1/2"		49,8	22	92
	7130/6	U1-12F	3/4"	3/4"		57,6	27	152
	7130/8	U1-16H	1"	1"		68	36	277
<b>SAE Flare / NPT reducing unions</b>								
	7140/21	U1-4A	1/4"	1/8"	120	32,9	12	20
	7140/32	U1-6B	3/8"	1/4"		41,1	17	39
	7140/34	U1-6D	3/8"	1/2"		45,8	22	77
	7140/43	U1-8C	1/2"	3/8"		45,2	20	63
	7140/54	U1-10D	5/8"	1/2"		53,8	23	102

TABLE 5: General characteristics of unions

	Catalogue Number	International Reference	Connections						PS [bar]	Dimensions [mm]		Weight [g]	
			SAE Flare		NPT	GAS	ODS			L	Ch		
			m	f			Ø [in.]	Ø [mm]					
<b>Male/female reducing unions (reduced female)</b>													
	7150/21	U3-4A	1/4"	-	1/8" f					120	29	14	21
	7150/32	UR3-46	3/8"	1/4"							33	17	38
	7150/42	UR3-48	1/2"	1/4"							35	22	75
	7150/43	UR3-68	1/2"	3/8"	-	-	-	-			38	22	66
	7150/54	UR3-810	5/8"	1/2"							45	25	99
	7150/64	UR3-812	3/4"	1/2"							46,5	27	132
	7150/65	UR3-1012	3/4"	5/8"							49,5	30	157
<b>Male/female reducing unions (reduced male)</b>													
	7150/X29	-	-	1/4"	1/8"					120	24	17	24
	7150/X27	-	-	1/4"	1/4"						30	17	35
	7150/23	UR3-64	1/4"	3/8"							33	22	49
	7150/24	UR3-84	1/4"	1/2"							36	25	66
	7150/34	UR3-86	3/8"	1/2"							39		74
	7150/45	UR3-108	1/2"	5/8"							44	30	125
	7150/46	UR3-128	1/2"	3/4"							45	34	142
	7150/56	UR3-1210	5/8"	3/4"							49	34	157
<b>Cylinder adaptors</b>													
	7154/2		1/4"	20 - 14 left thread, female						45	25	46	
	7156/2		1/4"	W 21,8 - 14 right thread, female						45	27	52	
<b>Male/female unions</b>													
	7160/2		1/4"	1/4"						45	30,5	17	31
	7160/3		3/8"	3/8"							36	22	57
	7160/4		1/2"	1/2"							41	25	84
<b>Unions SAE-Flare to BSP</b>													
	7164/2		1/4"	-		G1/4" f				45	32,5	20	45
	7166/2		-	1/4"		G1/4" m					32	17	25

Continued

TABLE 5: General characteristics of unions

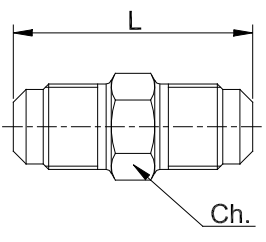
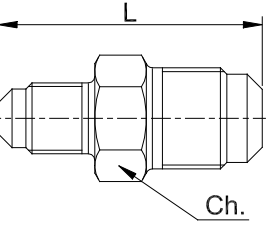
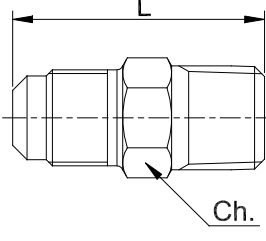
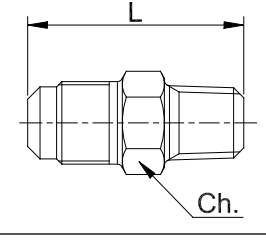
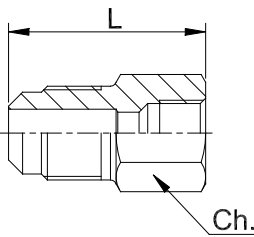
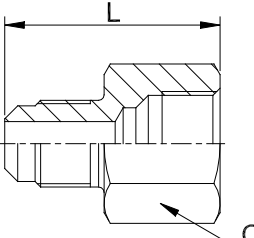
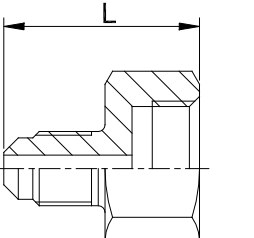
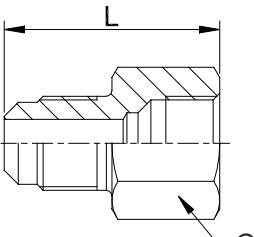
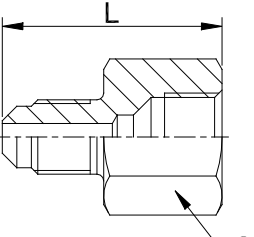
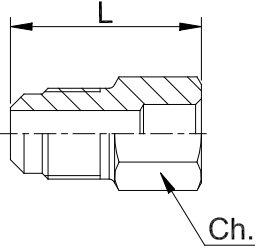
	Catalogue Number	International Reference	Connections					PS [bar]	Dimensions [mm]		Weight [g]	
			SAE Flare		NPT	GAS	ODS		L	Ch		
			m	f			Ø [in.]					Ø [mm]
Male SAE-Flare/solder unions												
	7170/22	US3-44	1/4"	-	-	-	1/4"	-	120	26,5	12	17
	7170/2M8	-					-	8				
	7170/33	US3-66	3/8"				3/8"	-		33	17	39
	7170/3M8	-					-	8				
	7170/3M10	-					-	10				
	7170/34	US3-68	1/2"				1/2"	-		35	20	53
	7170/44	US3-88					-	12				
	7170/4M12	-	5/8"				5/8"	16		42	23	82
	7170/55	US3-1010					-	18				
	7170/6M18	-					-	16		45,5	27	123
	7170/65	US3-1210	3/4"				5/8"	16		50	36	241
	7170/87	US3-1614					7/8"	22				

**TABLE 6: General characteristics of unions**

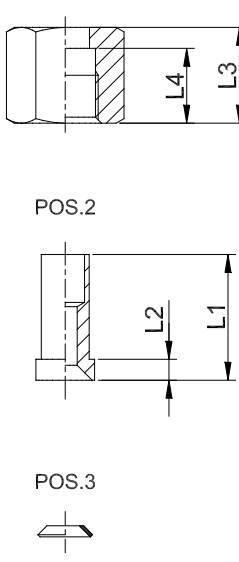
	Catalogue Number	Item Position	Connections			PS [bar]	Dimensions [mm]					Wrench torque min / max [Nm]	Weight [g]
			SAE Flare	ODS			L <sub>1</sub>	L <sub>2</sub>	L <sub>3</sub>	L <sub>4</sub>	Ch		
				Ø [in.]	Ø [mm]								
Flare / ODS adapters													
	9901/X11	1	1/4"	-	6	120	-	-	16	12,5	17	11 / 14	274
		2					21	3,5	-	-	-	-	
		3					-						
	9901/X12	1	3/8"	-	10		-	-	18,5	14,7	22	20 / 25	393
		2					23,5	4	-	-	-	-	
		3					-						
	9901/X13	1	1/2"	-	12		-	-	21	17	27	34 / 47	672
		2					26	4,5	-	-	-	-	
		3					-						
	9901/X14	1	5/8"	5/8"	16		-	-	22,5	18	30	54 / 75	511
		2					27,5	5	-	-	-	-	
		3					-						
9901/X15	1	3/4"	-	18	-	-	25	20	36	68 / 71	806		
	2				30	5	-	-	-	-			
	3				-								
9901/X16	1	1/4"	1/4"	-	-	-	16	12,5	17	11 / 14	274		
	2				21	3,5	-	-	-	-			
	3				-								
9901/X17	1	3/8"	3/8"	-	-	-	18,5	14,7	22	20 / 25	383		
	2				23,5	4	-	-	-	-			
	3				-								
9901/X18	1	1/2"	1/2"	-	-	-	21	17	27	34 / 47	672		
	2				26	4,5	-	-	-	-			
	3				-								
9901/X19	1	3/4"	3/4"	-	-	-	25	20	36	68 / 71	806		
	2				30	5	-	-	-	-			
	3				-								

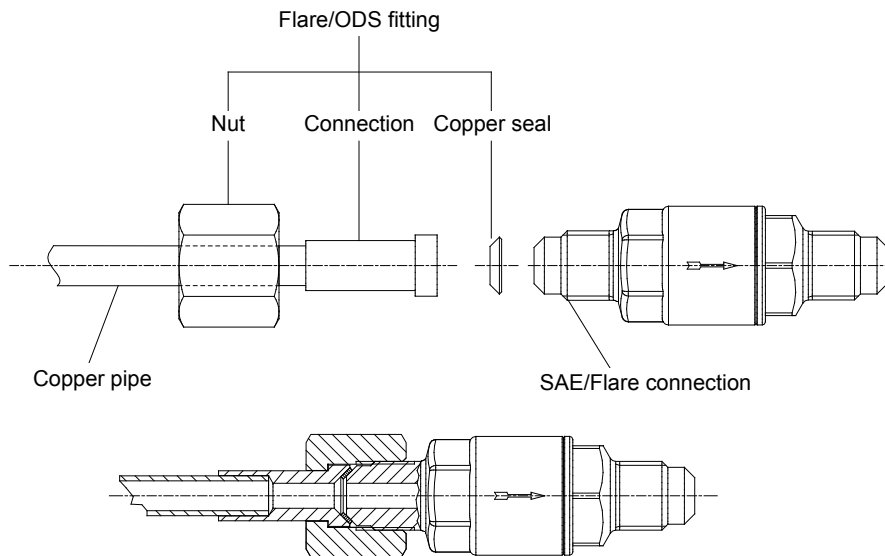
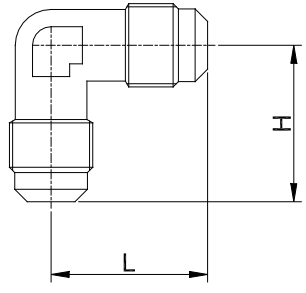
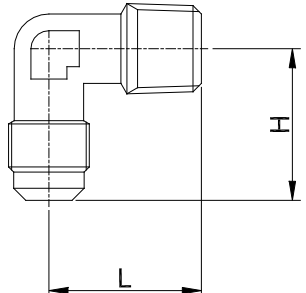
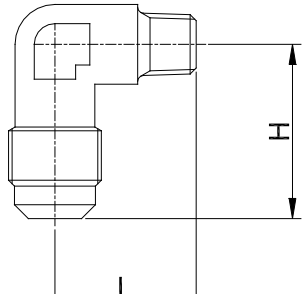
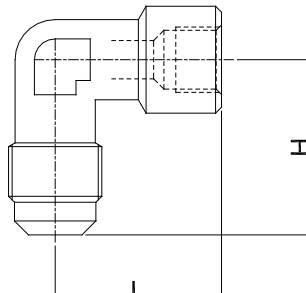

TABLE 7: General characteristics of unions



	Catalogue Number	International Reference	Connections			PS [bar]	Dimensions [mm]		Weight [g]
			SAE Flare		NPT		H	L	
			m	f					
<b>SAE-Flare elbows</b>									
	7210/2	E2-4	1/4"			120	24,5	24,5	24
	7210/3	E2-6	3/8"				29,5	29,5	60
	7210/4	E2-8	1/2"	-	-		32,5	32,5	80
	7210/5	E2-10	5/8"				36	36	116
	7210/6	E2-12	3/4"				42,5	42,5	192
<b>SAE-Flare / NPT elbows</b>									
	7220/2	E1-4B	1/4"		1/4"	120	26	24	33
	7220/3	E1-6C	3/8"		3/8"		29,5	28,5	54
	7220/4	E1-8D	1/2"	-	1/2"		32,5	32	91
	7220/6	E1-12F	3/4"		3/4"		42,5	39,5	183
<b>SAE-Flare / reduced NPT elbows</b>									
	7230/21	E1-4A	1/4"		1/8"	120	24,5	23,5	25
	7230/32	E1-6B	3/8"		1/4"		29,5	29,5	46
	7230/43	E1-8C	1/2"	-	3/8"		32,5	31	97
	7230/54	E1-10D	5/8"		1/2"		36	35	112
<b>Male/female SAE-Flare elbows</b>									
	7240/2		1/4"	1/4"		120	28,5	28	56
	7240/3	-	3/8"	3/8"	-		32	31	80
	7240/4		1/2"	1/2"			39,5	38	200



**TABLE 8: General characteristics of unions**

	Catalogue Number	International Reference	Connections					PS [bar]	Dimensions [mm]		Weight [g]
			SAE Flare				NPT (3)		H	L	
			(1)	(2)	(3)	(4)					
<b>SAE-Flare TEE</b>											
	7310/2	T2-4	1/4"	1/4"	1/4"	-	-	120	23,5	47	35
	7310/3	T2-6	3/8"	3/8"	3/8"				29	58	70
	7310/4	T2-8	1/2"	1/2"	1/2"				31,5	63	98
	7310/5	T2-10	5/8"	5/8"	5/8"				36	72	150
	7310/6	T2-12	3/4"	3/4"	3/4"				41,5	83	235
<b>SAE-Flare reducing TEE ( reduced side connections)</b>											
	7320/223	TR2-46	1/4"	1/4"	3/8"	-	-	120	29	56	77
	7320/334	TR2-68	3/8"	3/8"	1/2"				32,5	63	95
	7320/445	TR2-810	1/2"	1/2"	5/8"				38	72	153
	7320/556	TR2-1012	5/8"	5/8"	3/4"				41,5	83	228
<b>SAE-Flare reducing TEE ( reduced central connection)</b>											
	7320/332	TR2-64	3/8"	3/8"	1/4"	-	-	120	28	58	77
	7320/443	TR2-86	1/2"	1/2"	3/8"				32,5	63	101
	7320/554	TR2-108	5/8"	5/8"	1/2"				38	72	149
	7320/665	TR2-1210	3/4"	3/4"	5/8"				41,5	83	232
<b>SAE-Flare / NPT TEE ( taper central connection)</b>											
	7330/221	T1-4A	1/4"	1/4"	-	-	1/8"	120	21	47	33
	7330/222	T1-4B	1/4"	1/4"			1/4"		24	51	45
	7330/332	T1-6B	3/8"	3/8"			1/4"		28	58	65
<b>Male/female SAE-Flare TEE (female central connection)</b>											
	7340/222	T6-4	1/4"	1/4"	1/4"	-	-	120	27,5	56	73
<b>SAE-Flare / NPT TEE ( taper central connection)</b>											
	7410/2	C1-4	1/4"	1/4"	1/4"	1/4"	-	120	52	52	72

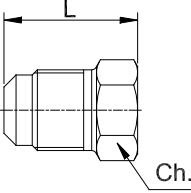
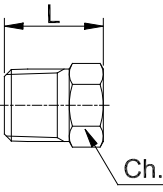
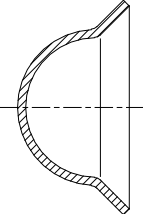
TABLE 9: General characteristics of unions

	Catalogue Number	International Reference	Connections		PS [bar]	Dimensions [mm]		Wrench torque min/max [Nm]	Weight [g]
			SAE Flare	NPT		L	Ch		
SAE-Flare plugs									
	7510/2	P2-4	1/4"	-	120	23	12	11 / 14	19
	7510/3	P2-6	3/8"			26	17	20 / 25	40
	7510/4	P2-8	1/2"			30	20	34 / 47	67
NPT plugs									
	7520/1	121-B-02	-	1/8"	120	15,9	12	10 / 13	12
	7520/2	121-B-04		1/4"		23,1	14	15 / 20	27
	7520/3	121-B-06		3/8"		23,2	17	17 / 22	43
	7520/4	121-B-08		1/2"		29,8	22	25 / 35	87
	7520/6	121-B-12		3/4"		32,1	27	30 / 40	149
	7520/8	121-B-16		1"		39	34	60 / 80	279
Copper seal caps									
	7560/2	B1-4	1/4"	-	45	-	-	-	0,5
	7560/3	B1-6	3/8"						1,1
	7560/4	B1-8	1/2"						2,5
	7560/5	B1-10	5/8"						2,6
	7560/6	B1-12	3/4"						3,7
	7560/7	B1-14	7/8"						5,3
Copper gaskets									
	7580/2	B2-4	1/4"	-	45	-	-	-	0,2
	7580/3	B2-6	3/8"						0,5
	7580/4	B2-8	1/2"						0,7
	7580/5	B2-10	5/8"						1,1
	7580/6	B2-12	3/4"						1,2

# CHAPTER 3

## ACCESS FITTINGS AND VALVE CORES

FOR REFRIGERATION PLANTS THAT USE HCFC, HFC, HC, HFO,  
OR R744 REFRIGERANTS



### APPLICATIONS

The access fittings illustrated in this chapter are designed for installation on commercial refrigeration systems and on civil and industrial air conditioning plants that use the following refrigerant fluids:

- HCFC (R22)
- HFC (R134a, R404A, R407C, R410A, or R507)
- HFO and HFO/HFC mixtures (R1234ze, R448A, R449A, R450A, and R452A)
- R744 subcritical and transcritical, limited to components with PS = 120 bar

belonging to Group 2, as defined in Article 13, Chapter 1, Point (b) of Directive 2014/68/EU, with reference to EC Regulation No. 1272/2008.

The access fittings illustrated in this chapter can be installed also on systems that use the following refrigerant fluids:

- HFC (R32)
- HFO (R1234yf)
- HC (R290, R600, or R600a)

belonging to Group 1, as defined in Article 13, Chapter 1, Point (a) of Directive 2014/68/EU, with reference to EC Regulation No. 1272/2008.

To use the valve cores with the various refrigerant fluids listed above, please refer to Table 14 in this chapter.

For specific applications with refrigerant fluids not listed above, please contact Castel Technical Department.

### OPERATION

The access fittings allow creating a loading or draining point rapidly and with a minimum expense. After completion of the filling or draining operations, use of the cap and gasket (p/n 8392/A or 8391/A) prevents any refrigerant leakage.

For special customer requirements, the cap 8392/A can be replaced by a blind union p/n 7020/20. The latter solution

requires that the union be tightened using a torque wrench to  $8.5 \div 11.5$  Nm. **Note: it is not necessary to use a copper gasket between union 7020/20 and the filling connector chosen.**

For systems using refrigerant fluid R410A, Castel has developed three specific filling connectors with 5/16" SAE-Flare connection (p/n 8350/X09, 8351/X05 and 8351/X07) that must be used with the following parts:

- Valve core, p/n 8395/A1 or 8395/A3
- Blind union, p/n 7020/X02

This solution for R410A requires to the union to be tightened with a torque wrench to  $8.5 \div 11.5$  Nm. **Note: also in this case, it is not necessary to use a copper gasket between union 7020/X02 and the filling connector chosen.**

If a component other than the two blind unions in series 7020 must be tightened on the access fittings (for example a pressure gauge), a tapered gasket with tang (p/n 8580/2) must be positioned between the component and the chosen access fitting.

The access fittings have different shapes and sizes, according to varying customer requirements. For all access fittings, the valve core seat is manufactured according to the ARI STANDARD 720:1997.

After tightening the valve core inside the access fitting with the dedicated wrench, p/n 8390/A, to the indicated torque, the refrigerant passage, filling or draining is obtained simply by activating the needle on the valve core.

### CONSTRUCTION

The straight fittings are machined by hexagonal brass bar EN 12164 – CW 614N.

The T and cross fittings are hot forged in brass EN 12420 – CW 617N.

Cap 8391/A is moulded Nylon.

Caps 8392/A and 8392/B are machined from hexagonal brass bar EN 12164 – CW 614N, with chloroprene rubber (CR) gasket.

Valve core 8394/B is equipped with chloroprene rubber (CR) and PTFE gaskets

Valve core 8395/A1 is equipped with chloroprene rubber (CR) gaskets

Valve core 8395/A3 is equipped with hydrogenated nitrile rubber (HNBR) gaskets

Valve core 8395/A4 is equipped with ethylene propylene rubber (EPDM) gaskets

The tapered gasket with tang, 8580/2, is manufactured from copper Cu - ETP UNI 5649.

TABLE 10: General characteristics of access fittings

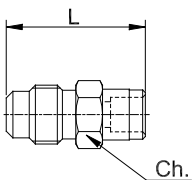
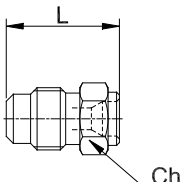
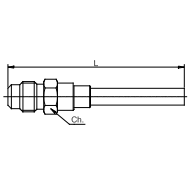
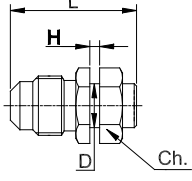
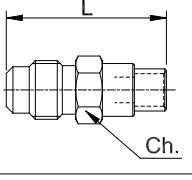
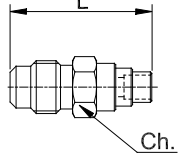
	Part number	Connections								PS [bar]	Dimensions [mm]				Weight [g]
		SAE Flare			NPT	ODS		IDS			L	Ch	D	H	
		Valve core	m	f		∅ [in.]	∅ [mm]	∅ [in.]	∅ [mm]						
Straight access fittings															
	8350/22	1/4"	-	-	-	1/4"	-	3/8"	-	120	26	11	-	-	12
	8350/X10	1/4"	-	-	-	1/4"	-	-	10		26	11	-	-	12
	8350/X01	1/4"	-	-	-	-	6	-	-	120	20	11	-	-	10
	8350/X03	1/4"	-	-	-	-	-	-	6	45	90	11	-	-	23
	8350/X06	1/4"	-	-	-	-	-	1/4"	-		126	11	-	-	28
	8350/X07	1/4"	-	-	-	-	-	1/4"	-		326	11	-	-	58
	8350/X12	1/4"	-	-	-	-	-	-	6		180	11	-	-	
	8350/X09	5/16"	-	-	-	1/4"	-	-	-	45	27	14	9,4	2,1	19
	8351/2	1/4"	-	-	-	-	6	-	8 - 10	120	30	11	-	-	13
	8351/X04	1/4"	-	-	-	-	-	-	6		26	11	-	-	11
	8351/X05	5/16"	-	-	-	-	-	3/8"	7		27	14	-	-	18
	8351/X07	5/16"	-	-	-	-	-	3/8"	6		27	14	-	-	19
	8351/X01	1/4"	-	-	-	-	1/8"	-	6	120	36	11	-	-	13
	8351/X02	1/4"	-	-	-	-	5	1/4" 5/16" 3/8"	-		26	11	-	-	11
	8351/X06	1/4"	-	-	-	-	-	-	6 8 10		28	11	-	-	13

Continued

TABLE 10: General characteristics of access fittings

	Part number	Connections								PS [bar]	Dimensions [mm]				Weight [g]
		SAE Flare			NPT	ODS		IDS			L	Ch	D	H	
		Valve core	m	f		∅ [in.]	∅ [mm]	∅ [in.]	∅ [mm]						
Straight access fittings															
	8352/22	1/4"	1/4"	-	-	-	-	-	-	120	31	11	-	-	15
	8354/21	1/4"	-	-	1/8"	-	-	-	-	120	28	11	-	-	13
	8354/22	1/4"	-	-	1/4"	-	-	-	-		33	14	-	-	25
	8354/23	1/4"	-	-	3/8"	-	-	-	-		38	17	-	-	41
	8362/22	1/4"	-	1/4"	-	-	-	-	-	120	35	17	-	-	42

TABLE 11: General characteristics of access fittings

	Part number	Connections					PS [bar]	Dimensions [mm]			Wrench torque min / max [Nm]	Weight [g]	Note
		SAE Flare		NPT	IDS			L	Ch	H			
		m	f		∅ [in.]	∅ [mm]							
TEE access fittings													
	8380/122	1/4"	-	1/8"	-	-	120	45	-	24	-	31	The valve core may be installed on each of the two 1/4" SAE Flare male connections
	8380/222	1/4"	-	1/4"	-	-		49,5	-	25,5	-	44	
	8380/X01	1/4"	-	-	-	6	120	43	-	24	-	28	
	8380/X02	1/4"	-	-	-	7	120	48	-	22	-	33	
	8380/X09	1/4"	1/4"	-	-	-	120	56	-	27	-	70	
TEE access fittings with swivel nuts													
	8380/X06	1/4"	1/4"	-	-	-	45	50	-	24	11/14	47	With valve-core opening device on female connection. The valve core may be installed on each of the two 1/4" SAE Flare connections
	8380/X08	1/4"	1/4"	-	-	-	45	49	17	24	11/14	49	The valve core may be installed on each of the two 1/4" SAE Flare male connections

**TABLE 12: General characteristics of access fittings**

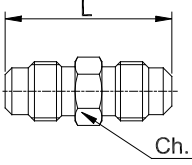
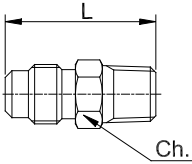
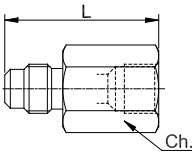
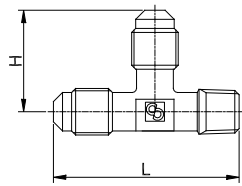
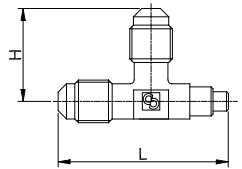
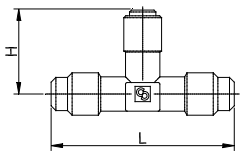
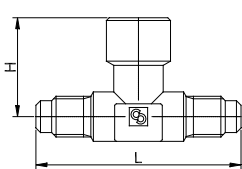
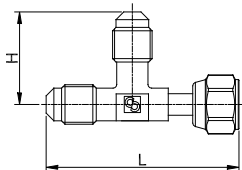
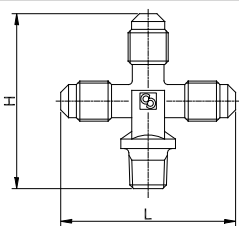
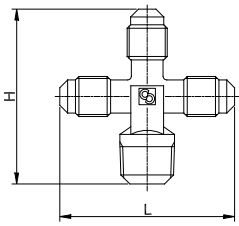
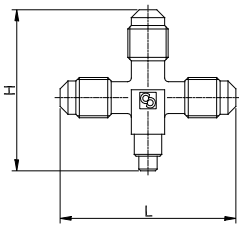
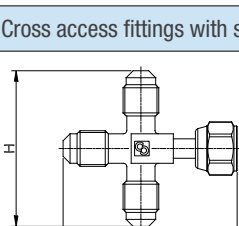

	Part number	Connections					PS [bar]	Dimensions [mm]			Wrench torque min / max [Nm]	Weight [g]	Note
		SAE Flare		NPT	IDS			L	Ch	H			
		m	f		Ø [in.]	Ø [mm]							
<b>Cross access fittings</b>													
	8382/1222	1/4"	-	1/8"	-	-	120	48	-	50	-	49	The valve core may be installed on each of the three 1/4" SAE Flare male connections
	8382/X02	1/4"	-	1/4"	-	-	120	48	-	50	-	53	
	8382/X01	1/4"	-	-	-	7-10	120	48	-	47	-	47	
	8382/X03	1/4"	-	-	-	6		48	-	44	-	42	
<b>Cross access fittings with swivel nut</b>													
	8382/X04	1/4"	1/4"	-	-	-	45	50	17	46	11/14	35	With valve-core opening device on female connection. The valve core may be installed on each of the three 1/4" SAE Flare connections

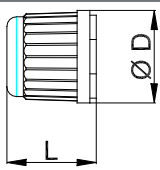
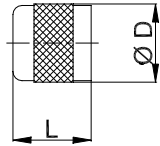
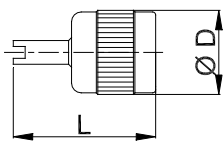
**TABLE 13: General characteristics of caps with gasket**

	Part number	Connections		PS [bar]	TS [°C]		Dimensions [mm]		Weight [g]
		SAE Flare			min	max	L	D	
	8391/A	-	1/4"	35	-20	+100	14	14	1
	8392/A	-	1/4"	80	-20	+100	13	13	7
	8392/B (1)	-	1/4"	80	-20	+100	22	13	7

(1) The key needs to remove the valve core

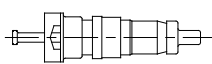
**TABLE 14: General characteristics of valve cores**

	Part number	Spring	Gaskets		Refrigerant Fluids	Max Static Pressure [bar]	Operating Pressure [bar]	Operating Temperature [°C]		Peak Temperature (1) [°C]	Dimensions [mm]		Wrench torque min / max (2) [Nm]	Weight [g]
			body	seat				min	max		L	D		
	8394/B	inside	PTFE	CR	R22 HFC (3)	40	28	-32	+100	125	19,5		0,30/0,35 Nm	1
	8395/A1	outside	CR	CR	R22 HFC (3) HFO (4)	140	60	-32	+100	125	16,3	5,2 x 0,705 V0.07.1	0,4/0,5 Nm	0,7
	8395/A3		HNBR	HNBR	HFC (3) HFO (4) HC (5)	140	60	-25	+130	150				
	8395/A4		EPDM	EPDM	R744	140	80	-35	+120	140				

Note:

(1) Permitted value for short periods



(2) To remove the valve core use the key code 8390/A

(3) R134a, R32, R404A, R407C, R410A, R507

(4) R1234yf, R1234ze, R448A, R449A, R450A, R452A

(5) R290, R600, R600a

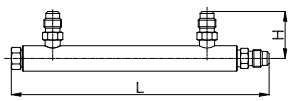
**TABLE 15: General characteristics of manifolds with access fittings**

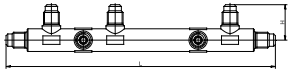
	Part number	Connections	PS [bar]	Dimensions [mm]		Weight [g]	Note
				SAE Flare	L		
	9900/X87	1/4"	45	162	30	36	N° 3 access fittings
	9900/X47	1/4"	45	175	30	216	N° 4 access fittings
	9900/X81	1/4"	45	190	25	343	N° 7 access fittings



[www.castel.it](http://www.castel.it)



ed. 001-AT-ENG

Castel can accept no responsibility for any errors or changes in the catalogues, handbooks, brochures and other printed material. Castel reserves the right to make changes and improvements to its products without notice. All trademarks mentioned are the property of their respective owners.  
The name and Castel logotype are registered trademarks of Castel Srl.  
All rights reserved.

Castel Srl - Via Provinciale 2-4 - 20060 Pessano con Bornago - MI